

# EL GRECO MINI WALLET

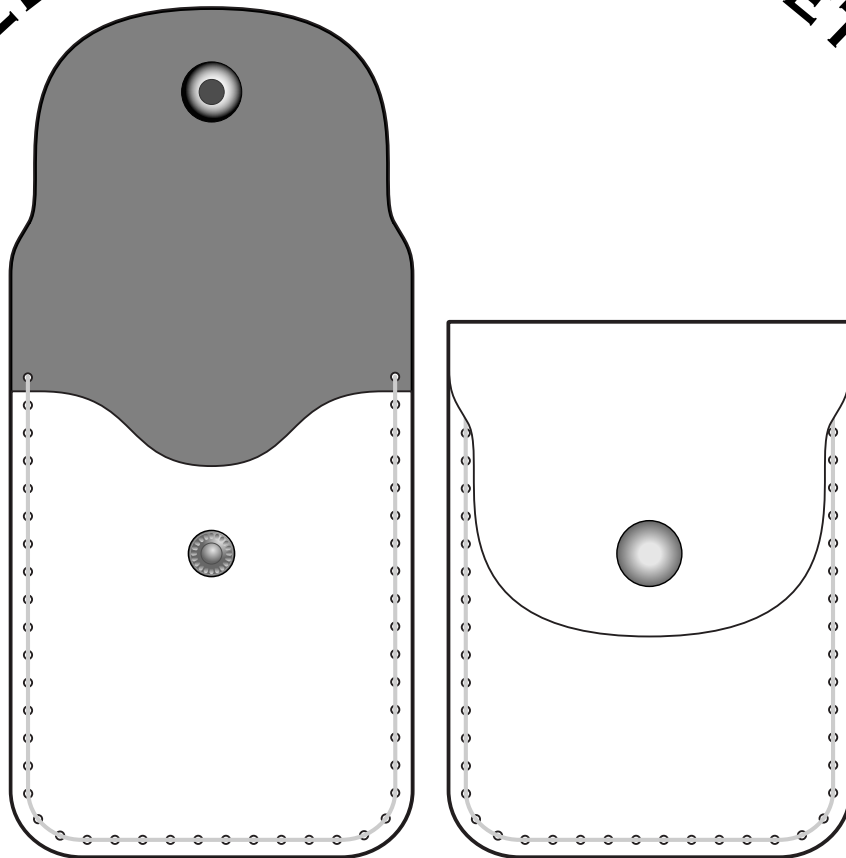

&

# BUCKLEGUY

LEATHERCRAFT SUPPLY

## ABOUT BUCKLEGUY

FOUNDED IN 1945, FOUR GENERATIONS OF OUR FAMILY HAVE SUPPORTED CLIENTS WITHIN THE MARKETS OF LEATHER GOODS AND ACCESSORIES. THROUGH THE GENERATIONS WE HAVE DISTRIBUTED LEATHER, TANNING MACHINERY, TOOLS, AND FOR THE PAST 40 YEARS MANUFACTURED SOLID BRASS HARDWARE FOR HIGH-END ACCESSORY BRANDS. SINCE 2000 WE HAVE OWNED AND OPERATED OUR OWN HARDWARE MANUFACTURING FACILITY.

IN 2010, WE STARTED BUCKLEGUY.COM AS A WHOLESALE SUPPLY WEBSITE FOR LEATHER CRAFTERS, HOBBYISTS, AND MANUFACTURERS IN SEARCH OF BETTER QUALITY PRODUCTS TYPICALLY UNAVAILABLE AT SMALL QUANTITIES. SINCE BUCKLEGUY'S INCEPTION WE HAVE SEEN A SURGE OF QUALITY DEMANDS FROM AMERICAN-MADE AND GLOBAL MAKERS THAT HAVE BEEN SEEKING SUPPLIES THAT ELEVATE THEIR OWN PRODUCTS. OVER TIME WE HAVE EXPANDED OUTSIDE OF HARDWARE AND PARTNERED WITH SOME OF THE BEST SUPPLY MANUFACTURERS IN THE WORLD IN THE MARKETS OF LEATHERS, ZIPPERS, TOOLS, THREADS, AND MORE.

ALL THE MATERIALS AND COMPONENTS THAT GO INTO OUR KITS COME FROM US AND OUR FAMILY OF VENDORS. WE ALSO DESIGN MANY OF THE KITS IN HOUSE. OUR MISSION IS TO MAKE THE FINEST LEATHER KITS WITH THE BEST MATERIALS THE MARKET HAS TO OFFER! WE HOPE YOU LOVE THEM!

---

THANKS FROM ALL OF US AT BUCKLEGUY!

PLEASE SHARE YOUR PROJECTS WITH US ON SOCIAL MEDIA

---



@BUCKLEGUYCOM



@BUCKLEGUY



@BUCKLEGUY



@BUCKLEGUY.COM

# BUCKLEGUY

LEATHERCRAFT SUPPLY

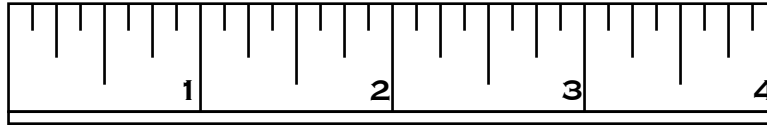

**PRINT THIS PAGE FIRST** AND MEASURE THIS RULER AGAINST YOUR OWN TO CHECK THAT IT IS PRINTING AT 100% SCALE.

### DIGITAL PDF PRINTING INSTRUCTIONS

**THE PATTERN IS DESIGNED TO BE PRINTABLE. WE TOOK INTO CONSIDERATION THE STANDARD PRINTER MARGINS FOR LETTER SIZED PAPER.**

**SELECT “US LETTER” (8.5” X 11”) UNDER PAPER SIZE. MAKE SURE PORTRAIT MODE IS SELECTED.**

**BE SURE TO CLICK “SCALE: 100%” AS SEEN HERE TO ENSURE THAT THE PAGE IS GOING TO PRINT TO SCALE.**

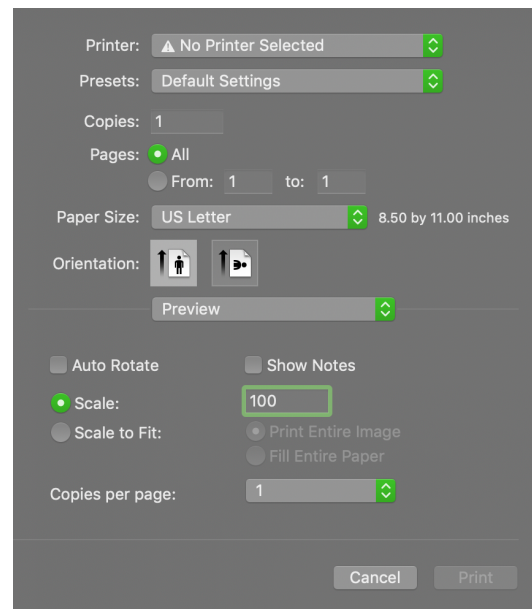

# BUCKLEGUY

LEATHERCRAFT SUPPLY

### Leather, Flesh vs. Grain:

The leather you are using has a front (Grain) and back (Flesh). The Grain is where the hair used to be until it was removed during the tanning process. This is the more beautiful and durable side that we always want showing on the outside of our goods. The Flesh side is the opposing side and is typically more rough and fibrous. We like to hide this side on the inside of our goods.



color coding in instructions

### Saddle Stitching

This is the hand stitching technique that we will be using on this good. Hand Stitching is a simple technique that is very durable. This process is done with 1 thread and 2 needles, one needle at each end of a single piece of thread.

#### Threading the Needles:

1. Send thread through the eye of the needle.
2. Send the point of needle through the center of the plies of thread 1/2” from the end on the part of the thread that has already been passed through the needle. (tip: place the thread on a hard surface, then stab needle through thread into the hard surface).
3. Pull thread all the way down the needle and off the eye end. Take long end and pull knot tight against needle eye.
4. Repeat on the other end.

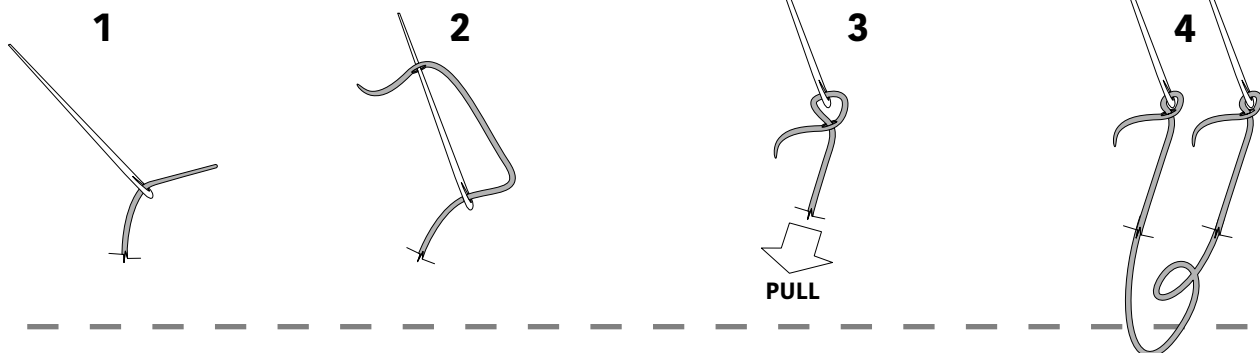

**Saddle Stitching cont.**

1. After you have a needle at each end of the length of thread, send the thread through the first hole with equal amounts of thread on either side of the project.
2. Stitch the front side of thread through the second hole and pinch as shown.
3. Switch to other needle and stitch the back side of thread through the second hole to front and then through third hole to back.
4. Repeat step 3 until last holes.

Note 1: If you make a mistake, unstitch and correct.

Note 2: Failure to maintain exact rythm detailed in step 3 will result in assymetric stitching. Asymmetry is common when starting out and perfect symmetry is one hallmark of a master handsewer :)

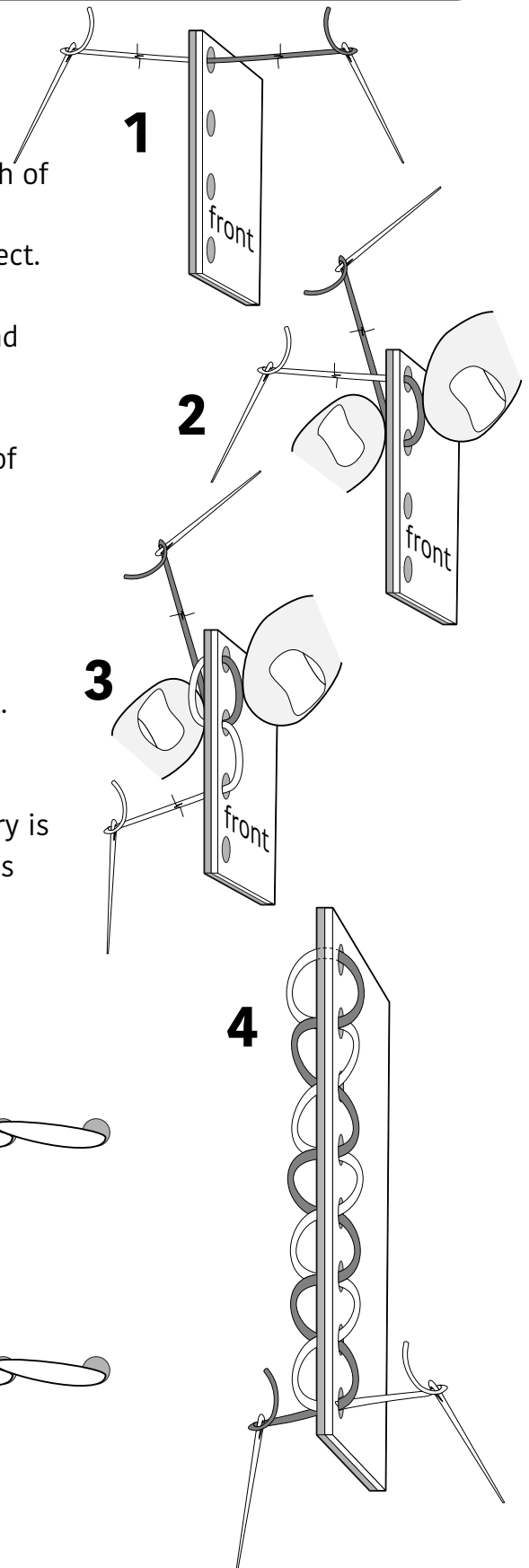

**Symmetry:**



**Asymmetry:**



**Stitch end options:**

Once stitching is complete (you have stitched the last hole possible) you must fix the loose thread ends. Depending on the construction of your project, you have a choice of a number of techniques for finishing a row of saddle stitching. Ideally you want the stitch to hold for the life of the item.

**Backstitching:**

Restitch through the last two/three holes again by stitching in the opposite direction and end with both tails on one face/side. This will lock in the threads. Finish by burning thread ends.



**Burning Threads:**

Most seams require you to trim the excess thread and melt the ends of the thread to seal and finish off the seam. To melt the threads, first trim both down to 1/8". Hold the seam with the trimmed thread flat and carefully bring down a lighter flame and slowly descend until the ends of the threads melt into a ball. Be careful not to touch the flame against any of the leather, especially if you're using a lighter colored leather.

**Square knot:**

The strongest solution is a square knot tied and hidden in an interior area with tails welded/burnt with a lighter. Not every construction can conceal this. Illustration indicating threads exiting between layers (1), tightly knotted (2&3), burnt/welded and then tucked back into seam with a scratch awl (4).

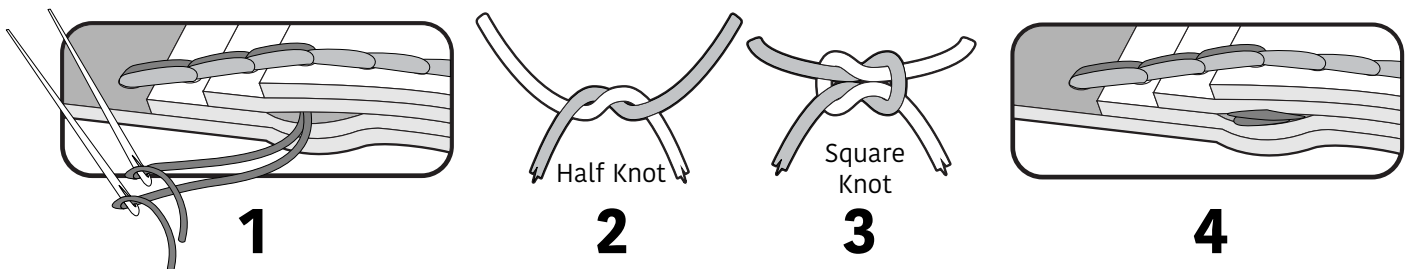

## Edge Finishing

**Sanding:** This is done before burnishing when you have multiple layers of leather stitched together. Use the sandpaper to lightly sand the sides of the leather until the multiple layers of leather are flush. Hold the sandpaper at an angle on the edge of leather to round any corners. This is not necessary on single layers.

**Burnishing** is the process of polishing the edges of leather. This is an aesthetic choice and is optional. The edges will burnish naturally on their own over time!

**To Burnish:** First use water to lightly dampen the edge. Wait ten seconds for it to seep in. Once wet, use the canvas cloth or a wood edge slicker to rub back and forth along edges until a light shine is achieved. When you're burnishing a single layer of leather, make sure that you are gentle. After this, rub beeswax along the edge and repeat the process of burnishing with the cloth or the wood edge slicker. This process can be repeated to darken or smooth further.

Note: If during the burnishing process edges peen over, sand the edge again at a 45° angle and re-burnish. If you have an edge beveler, you can take off the corners and round off the edges before repeating the burnish process.

BELOW ARE ALL OF THE 3-4OZ. LEATHER PATTERN PIECES INCLUDED IN THIS KIT.  
THERE ARE 3 PATTERN PIECES TOTAL.

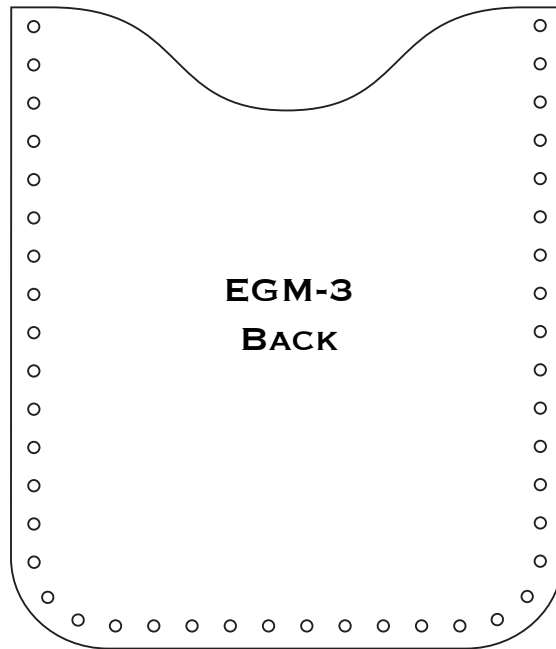
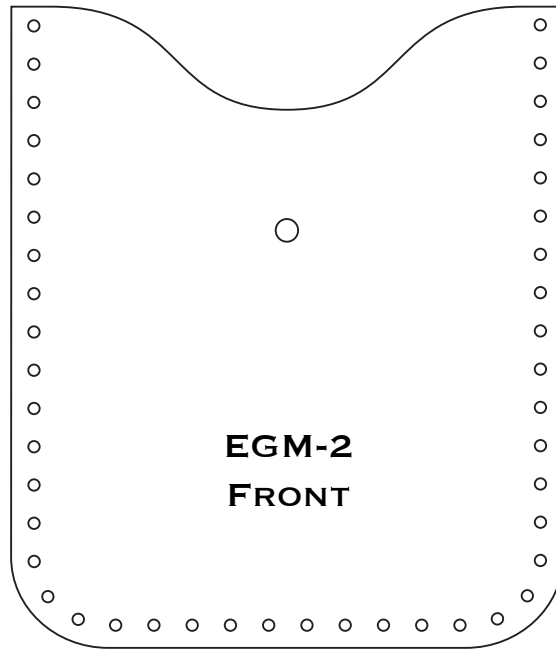
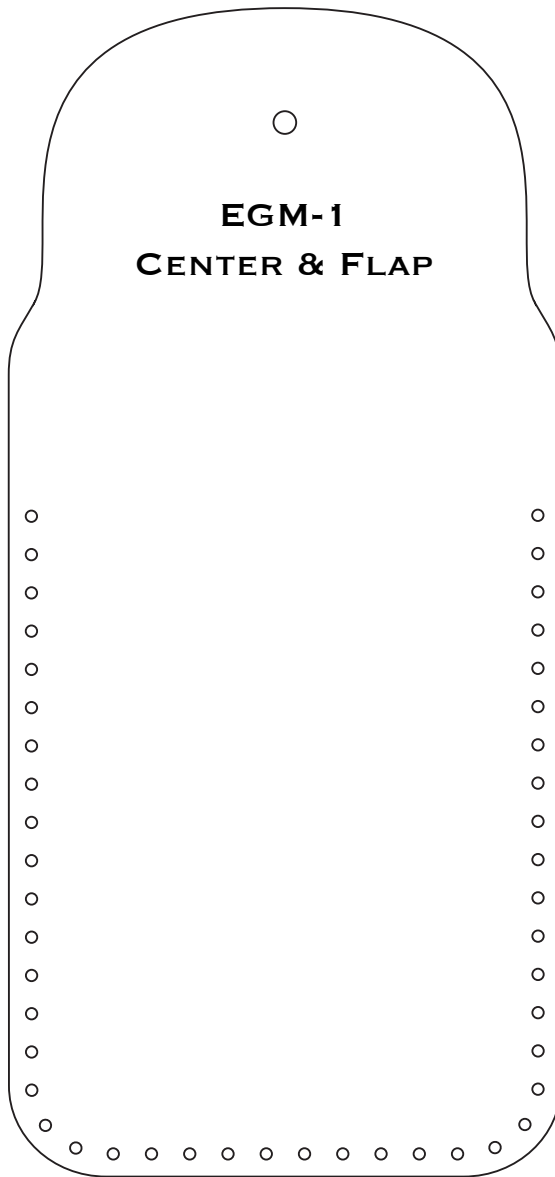

**BUCKLEGUY**

LEATHERCRAFT SUPPLY



**3-4OZ. LEATHER PIECES:**

1. CENTER & FLAP.
2. FRONT.
3. BACK.

**STITCHING AND BURNISHING**

**SUPPLIES:**

- +NEEDLES
- +THREAD: (1) @40"
- +CANVAS
- +SANDPAPER
- +BEESWAX

**HARDWARE**

- +SNAP FASTENER: S127B50-LP (4 COMPONENTS).

**STEP 1:** (Optional) Burnish edges marked by grey lines below:

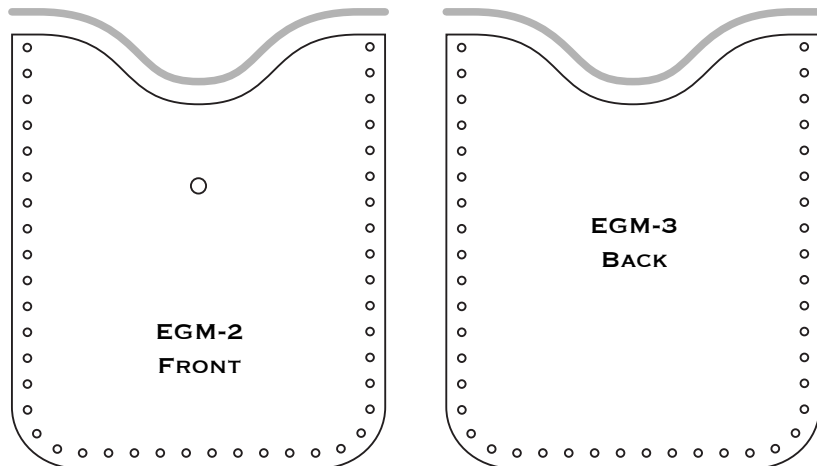

**BUCKLEGUY**

LEATHERCRAFT SUPPLY

**STEP 2:** If you purchased the leather kit, the closure has already been affixed, so you may skip to step three. If you are assembling from the PDF pattern or acrylic template and have selected a non-snap closure, follow the respective assembly for your hardware using the center hole in Center & Flap (1) and Front (2) for reference and install. Snap closure installation detailed here:

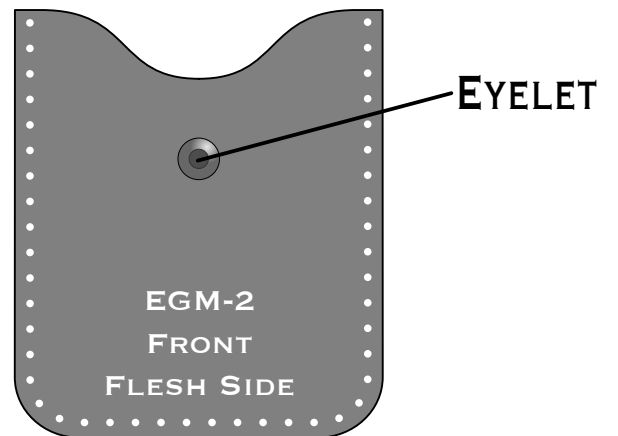
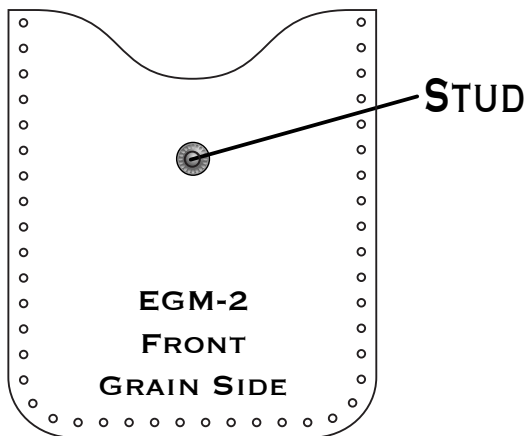
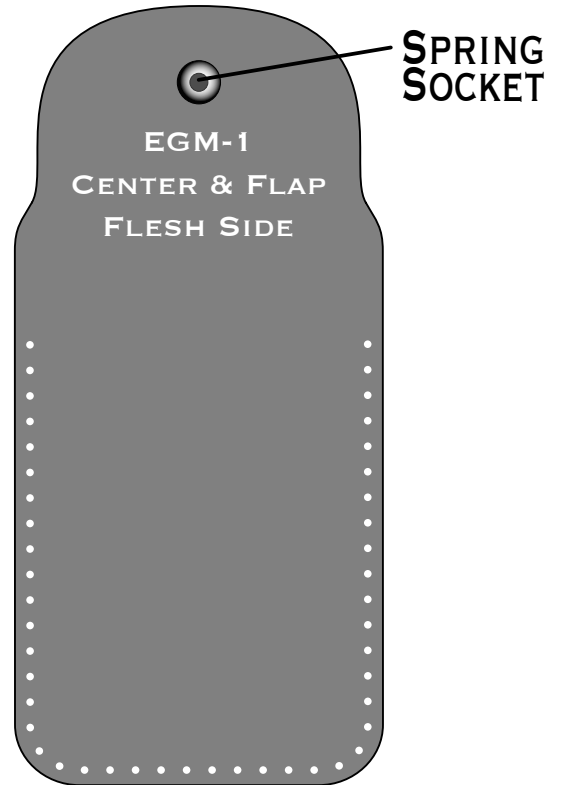
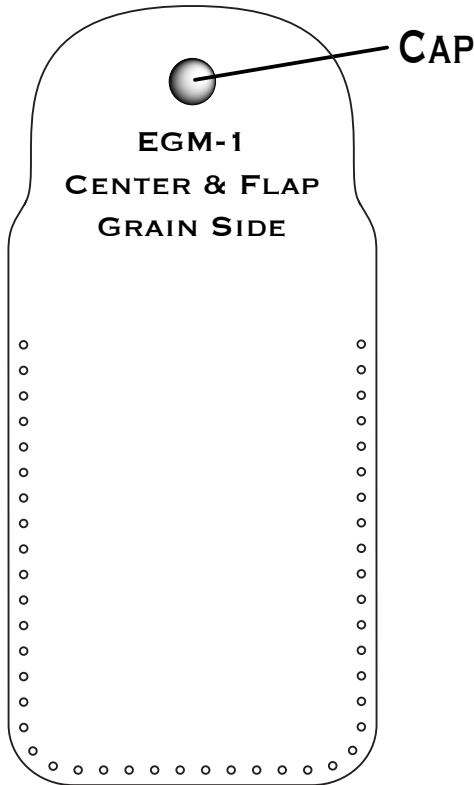

BUCKLEGUY

LEATHERCRAFT SUPPLY

**STEP 3:** Align stitch holes in all three components with grain/flesh sides oriented as below. Prepare your needles on the 40" thread and begin a saddle stitch at ★. Back-stitch, tie and burn at ☐.

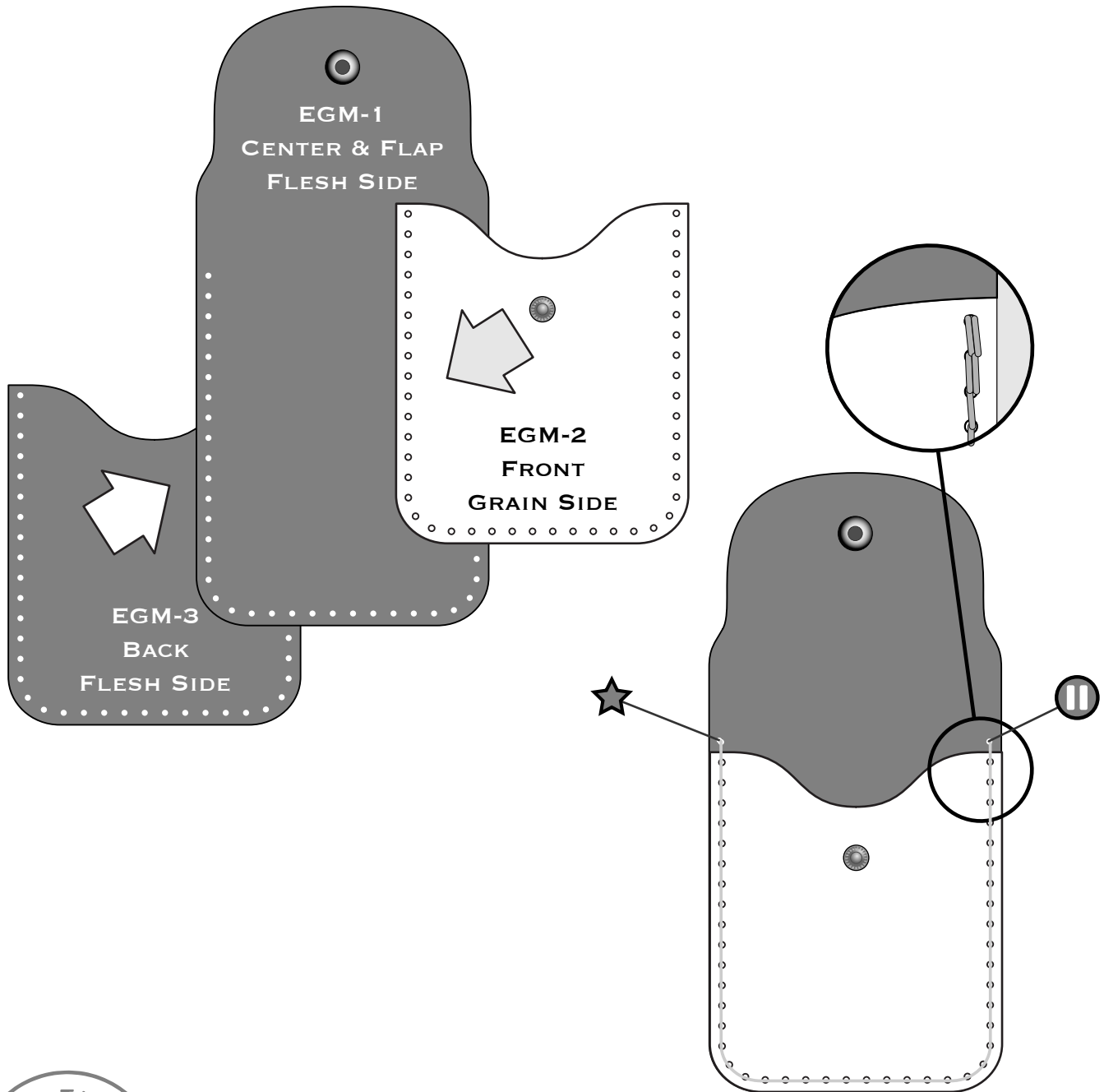

BUCKLEGUY

LEATHERCRAFT SUPPLY

STEP 4 : (Optional) Burnish edges marked by grey lines below:

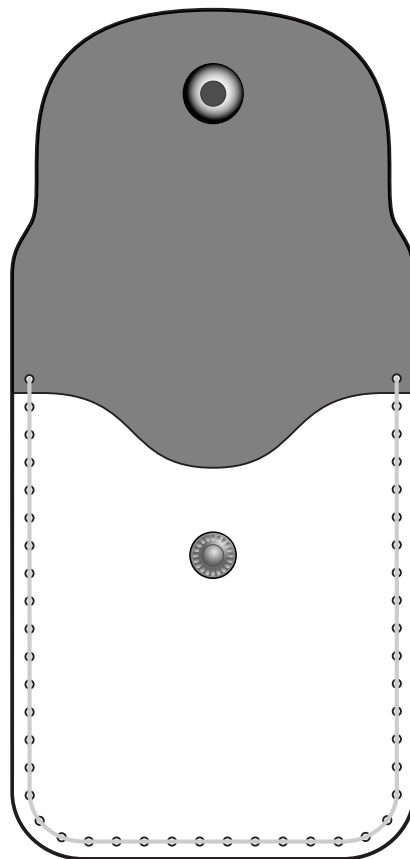
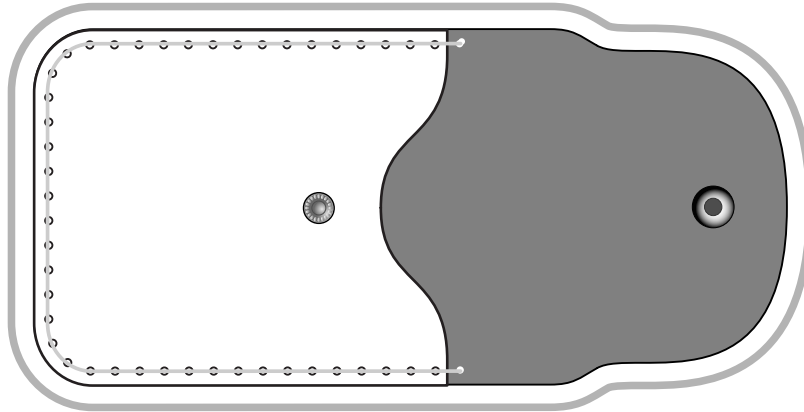

ALL DONE! ENJOY YOUR  
NEW CARDHOLDER!

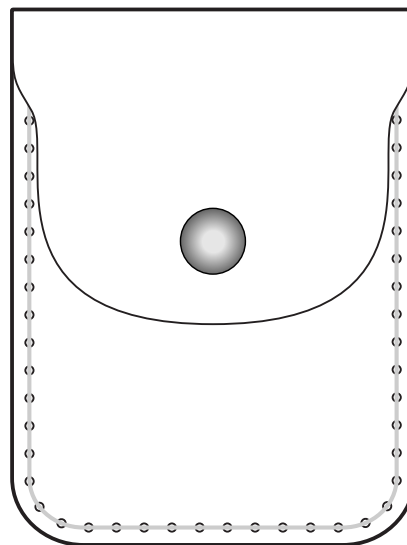

BUCKLEGUY

LEATHERCRAFT SUPPLY